

MC-S368

High Sensitivity x36 Zoom Module

LVDS EX-SDI CVBS



Features

- 1/2" 2MP Sony CMOS sensor
- 1080p 60fps/30fps, 720p 60fps
- x36 Optical Zoom(6mm~216mm) & x32 Digital Zoom
- F1.5(wide) ~ F4.8(tele)
- Day & Night(ICR)
- Real-time True WDR
- Digital Noise Reduction(2D+3D)
- Digital Image Stabilizer
- Privacy Mask Function
- High Light Compensation
- Intelligent Motion Detection
- Defog Function
- Supports VISCA, Pelco-D/P Protocol
- Video Out : LVDS, EX-SDI, CVBS

Dimensions

Unit : mm

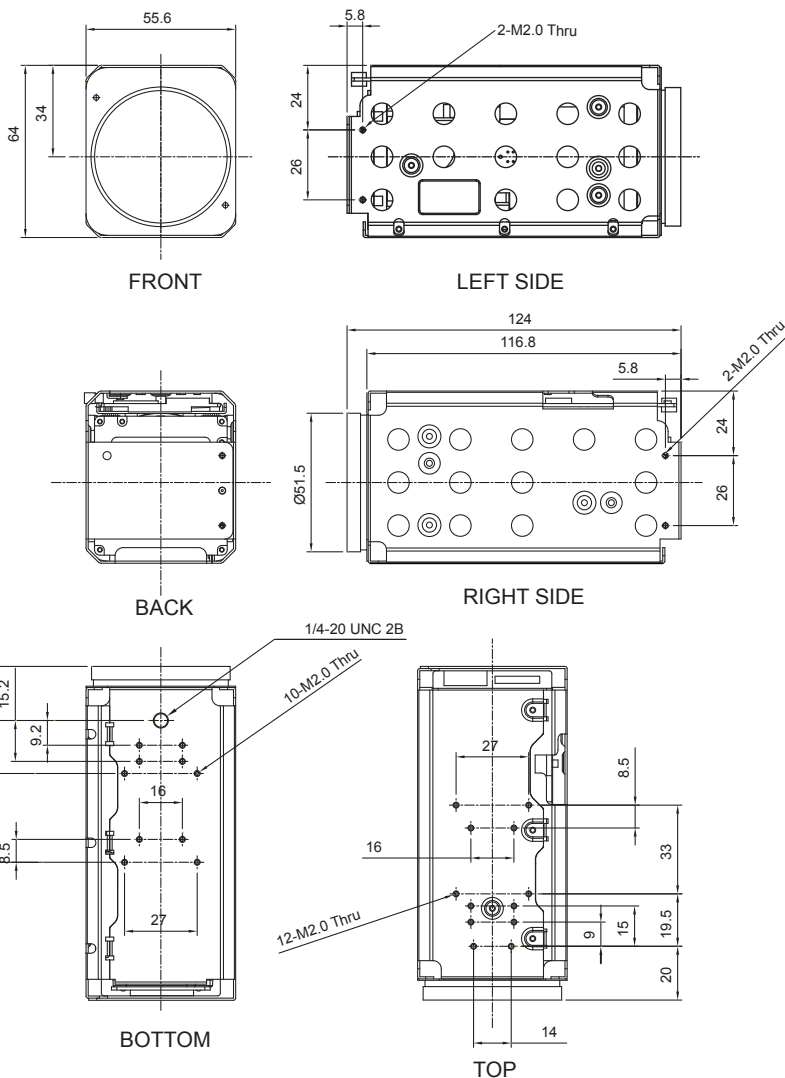

Field of View

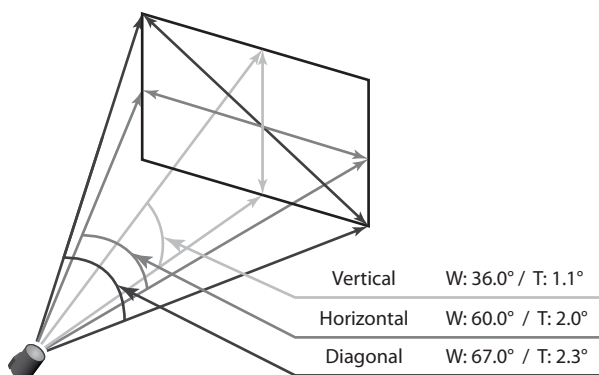

Specifications

MC-S368				
Image Sensor	1/2" Sony CMOS Sensor			
Total Pixels	1,952(H) x 1,241(V) = 2.42M Pixels			
Active Pixels	1,937,(H) x 1,097 (V) = 2.12M Pixels			
Scanning System	Progressive Scan			
Sync. System	Internal			
Resolution	Digital ; 1080p/60(50)fps, 1080p/30(25)fps, 720p/60(50)fps, 720p/30(25)fps Analog : 700TVL			
Min. Illumination	Color(1/30s) : 0.15 lux , BW(1/30s) : 0.01lux Color DSS(1/7.5s) : 0.0375 lux , BW DSS(1/7.5s) : 0.002 lux			
Video Output	HD : Digital(LVDS), EX-SDI Analog SD : VBS(without WDR)			
S/N Ratio	more than 50dB (AGC off)			
Lens Type	x36 Day & Night Zoom Lens			
Zoom Ratio	Optical x36, Digital x32 Zoom			
Focal Length	f = 6.0 mm ~ 216.0 mm			
Aperture Ratio	F1.5 (wide) ~ F4.8 (tele)			
Angle Of View(D, H, V)	Wide	67.0°	60.0°	36.0°
	Tele	2.3°	2.0°	1.1°
Focus	Mode / Distance / Zoom Speed / Lens Refresh / E.Zoom			
Mode	Auto / One Push / Manual			
Distance	0.1 / 1.5 / 3.0 / 5.0 / 10.0 m			
Lens Refresh	One Push / 1 ~ 10Day			
Digital Zoom	Off / MAX x2 ~ x32			
Exposure	AUTO / IRIS.P / SHUT.P / MANUAL			
Gain Control(AGC)	Off / On			
Shutter Speed	1/30(25) ~ 1/30,000 sec			
Iris	0 ~ 20			
Digital Slow Shutter(DSS)	Off / x2 / x4(x8 : 60 or 50 fps mode only)			
Brightness	0 ~ 20 steps			
WDR/BLC	OFF / WDR / BLC			
Day&Night	Auto / Day / Night / Ext-in			
White Balance	Auto / One Push / Manual / Indoor / Outdoor			
HLC	Off / On / Night Only			
DNR	Auto / Off / Low / Middle / High			
Mirror	Off / H / V / H&V			
Sharpness	0 ~ 10 steps			
ACE	Off / Low / Middle / High			
Defog	Off / On(Auto / Manual)			
Privacy Mask	Off / 24 positions			
Motion Detection	Off / 3 positions			
Defect Detection	Off / On			
System	NTSC / PAL			
HD Format	1080p/30(25)fps / 1080p/60(50)fps / 720p/30(25)fps / 720p/60(50)fps			
Communication	Baud Rate : 2400 / 4800 / 9600 / 19200 / 38400 / 57600 / 115200 Protocol : VISCA / Pelco-D / Pelco- P / Update			
Language	English / Simplified Chinese / Traditional Chinese / Japanese			
Power Source	9V to 15V DC			
Power Consumption	500mA			
Power Input	Connector			
Video Output	Connector			
Storage Temperature	-20℃ ~ +60℃ (Humidity : 0%RH ~ 90%RH)			
Operating Temperature	-10℃ ~ +50℃ (Humidity : 0%RH ~ 90%RH)			
Dimensions	55.6(W) x 64(H) x 124(D)			
Weight	400g			

Pin Assignment

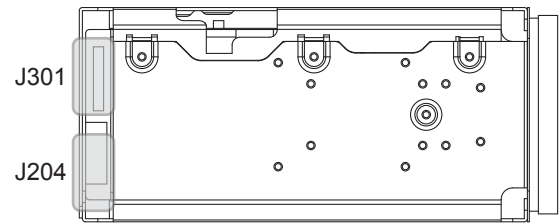

J301	
1	TXOUT3+
2	TXOUT3-
3	TXCLKOUT+
4	TXCLKOUT-
5	TXOUT2+
6	TXOUT2-
7	TXOUT1+
8	TXOUT1-
9	TXOUT0+
10	TXOUT0-
11	GND
12	TxD
13	RxD
14	DC IN
15	DC IN
16	DC IN
17	DC IN
18	DC IN
19	GND
20	GND
21	TXOUT7+
22	TXOUT7-
23	TXOUT6+
24	TXOUT6-
25	EXSDI+
26	EXSDI-
27	TXOUT5+
28	TXOUT5-
29	TXOUT4+
30	TXOUT4-

J204	
1	GND
2	TxD
3	RxD
4	NC
5	GND
6	NC
7	GND
8	ADKEY
9	NC
10	D/N-IN
11	NC
12	MD-OUT
13	485-DIR
14	F/W_SEL
15	GND
16	+5V
17	GND
18	VBS-OUT
19	GND
20	DC IN
21	DC IN
22	DC IN
23	DC IN
24	DC IN

Ref 05002HR-24J05(YEONHO)

Ref USL00-30L-C(KEL Cop.)

* Design and specifications are subject to change without notice.