

MC-108B

1080p 60fps x10 Zoom Module

HD-SDI EX-SDI TVI 2.0 CVBS



Features

- 1/3" 2MP Panasonic CMOS sensor
- 1080p 60fps/30fps, 720p 60fps
- x10 Optical Zoom(5.1~51mm) & x32 Digital Zoom
- Day & Night(ICR)
- Real-time True WDR
- Digital Noise Reduction(2D+3D)
- Privacy Mask Function
- Digital Image Stabilizer
- High Light Compensation
- Intelligent Motion Detection
- Defog Function
- Supports VISCA, Pelco-D/P Protocol
- Video Out : HD-SDI, EX-SDI, TVI 2.0, CVBS

Field of View

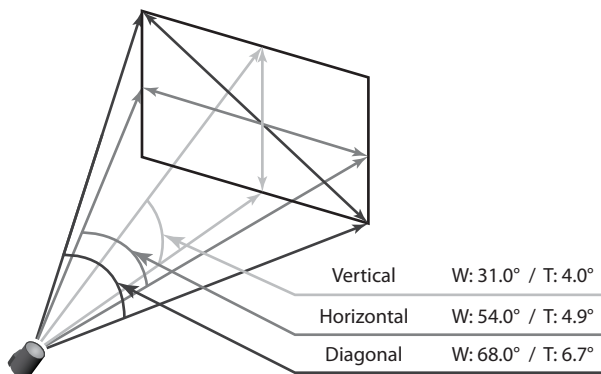

Dimensions

Unit : mm

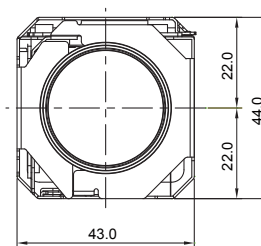

FRONT

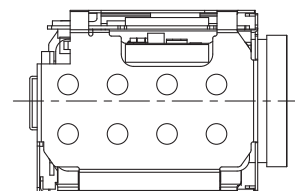

LEFT SIDE

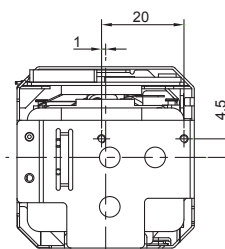

BACK

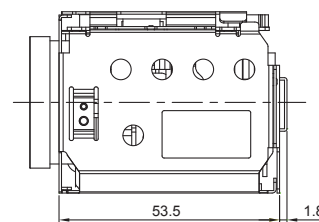

RIGHT SIDE

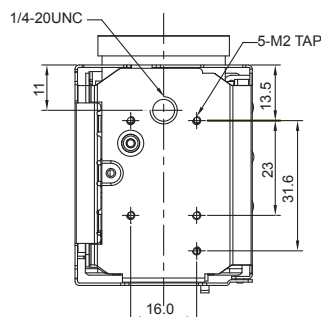

BOTTOM

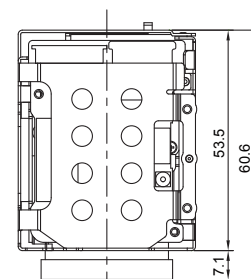

TOP

Specifications

MC-108B	
Image Sensor	1/3" Panasonic CMOS Sensor
Total Pixels	1956 (H) x 1266 (V) = 2.48M Pixels
Active Pixels	1944 (H) x 1092 (V) = 2.12M Pixels
Scanning System	Progressive Scan
Sync. System	Internal
Resolution	Digital : 1080p/60(50)fps, 1080p/30(25)fps, 720p/60(50)fps, 720p/30(25)fps Analog : 700TVL
Min. Illumination	Color : 0.5 lux , BW : 0.1lux Color DSS : 0.125 lux , BW DSS : 0.025 lux
Video Output	HD : HD-SDI, EX-SDI, TVI 2.0 Analog SD : VBS(without WDR)
S/N Ratio	more than 50dB (AGC off)
Lens Type	X10 Day & Night Zoom Lens
Zoom Ratio	Optical x10, Digital x32 Zoom
Focal Length	f = 5.1mm ~ 51mm
Aperture Ratio	F1.6 (wide) ~ F1.8 (tele)
Angle Of View(D, H, V)	Wide 68° 54° 31° Tele 6.7° 4.9° 4.0°
Focus	Mode / Distance / Zoom Speed / Lens Refresh / E.Zoom
Mode	Auto / One Push / Manual
Distance	0.1 / 1.0 / 3.0 / 6.0 / 10.0 m
Lens Refresh	One Push / 1 ~ 10Day
Digital Zoom	Off / MAX x2 ~ x32
Exposure	Auto / Iris.P / Shut.P / Manual
Gain Control(AGC)	Off / On
Shutter Speed	1/30(25) ~ 1/30,000 sec
Iris	0 ~ 20
Digital Slow Shutter(DSS)	Off / x2 / x4(x8 : 60 or 50 fps mode only)
Brightness	0 ~ 20 steps
WDR/BLC	Off / WDR / BLC
Day&Night	Auto / Day / Night / Ext-in
White Balance	Auto / One Push / Manual / Indoor / Outdoor
HLC	Off / On / Night Only
DNR	Auto / Off / Low / Middle / High
Mirror	Off / H / V / H&V
Sharpness	0 ~ 10 steps
ACE	Off / Low / Middle / High
Defog	Off / On(Auto / Manual)
Privacy Mask	Off / 24 positions
Motion Detection	Off / 3 positions
Defect Detection	Off / On
System	NTSC / PAL
HD Format	1080p/30(25)fps / 1080p/60(50)fps / 720p/30(25)fps / 720p/60(50)fps
Communication	Baud Rate : 2400 / 4800 / 9600 / 19200 / 38400 / 57600 / 115200 Protocol : VISCA / Pelco-D / Pelco- P / Update
Language	English / Simplified Chinese / Traditional Chinese / Japanese
Power Source	9V to 15V DC
Power Consumption	250mA
Power Input	Connector
Video Output	Connector
Storage Temperature	-20℃ ~ +60℃ (Humidity : 0%RH ~ 90%RH)
Operating Temperature	-10℃ ~ +50℃ (Humidity : 0%RH ~ 90%RH)
Dimensions	43(W) x 44(H) x 61(D)
Weight	112g

* Design and specifications are subject to change without notice.

Pin Assignment

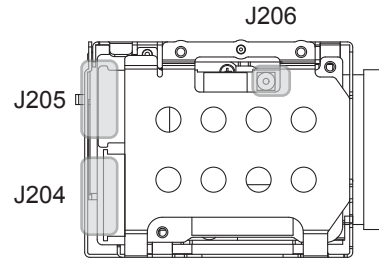

J205	
1	RXD
2	TXD
3	GND
4	DC 12V_IN
5	GND
6	VIDEO
7	GND
8	TVI_OUT
9	GND

Ref 6200-509-130(KYOCERA)

J206	
1	HD-SDI Output
2	Board Ground

Ref RF Connector – MMCX

J204	
1	GND
2	TxD
3	RxD
4	TVI ON
5	GND
6	TVI-OUT
7	GND
8	ADKEY
9	IR-ON
10	D/N-IN
11	EX-SDI ON
12	MD-OUT
13	485-DIR
14	F/W_SEL
15	GND
16	+5V_OUT
17	GND
18	VBS-OUT
19	GND
20	DC 12V
21	DC 12V
22	DC 12V
23	DC 12V
24	DC 12V

Ref 05002HR-24J05(YEONHO)