

DL5028UC-MPY

f=50mm F2.8

for 1/1.1 Type 12Megapixel cameras, Motorized Control Fixed-focal

USB interface, C-Mount

Optical Specifications

Model No.		DL5028UC-MPY		Effective Lens Aperture		Front:φ22.9mm Rear:φ14.6mm	
Focal Length		50mm		Back Focal Length		14.2mm (in Air)	
Operation Range	Iris	F2.8 - F16.0		Flange Back Length		17.526mm (In Air)	
	Focus	0.2m - Inf.		Max. Image Circle		φ14.4mm	
Object Dimension at M.O.D.	1/1.1 Type	55.7mm x 40.8mm		Distortion	1/1.1 Type	0.0%	
	2/3 Type	43.6mm x 32.7mm			2/3 Type	0.0%	
	1/1.8 Type	35.7mm x 26.7mm			1/1.8 Type	0.0%	
Angle of View	D	1/1.1 Type	16.3°	2/3 Type	12.9°	1/1.8 Type	10.6°
	H	11.22mm x 8.22mm	13.2°	8.8mm x 6.6mm	10.4°	7.2mm x 5.4mm	8.5°
	V	(φ13.9mm)	9.7°	(φ11.0mm)	7.8°	(φ9.0mm)	6.4°

Mechanical & Electrical Specifications

Control Interface		USB2.0		Dimensions		As per the attached drawing	
Power mode		Bus powerd (500mA)		Mount		C-Mount	
Connector		USB TypeA		Weight		173g	
Operating Temperature		-20°C - +60°C		Tripod Screw		-	
Control	Iris	Motorized		Filter thread		M30.5 x P0.5mm	
	Focus	Motorized		IRCF switcher		-	

Dimensions

Unit:mm

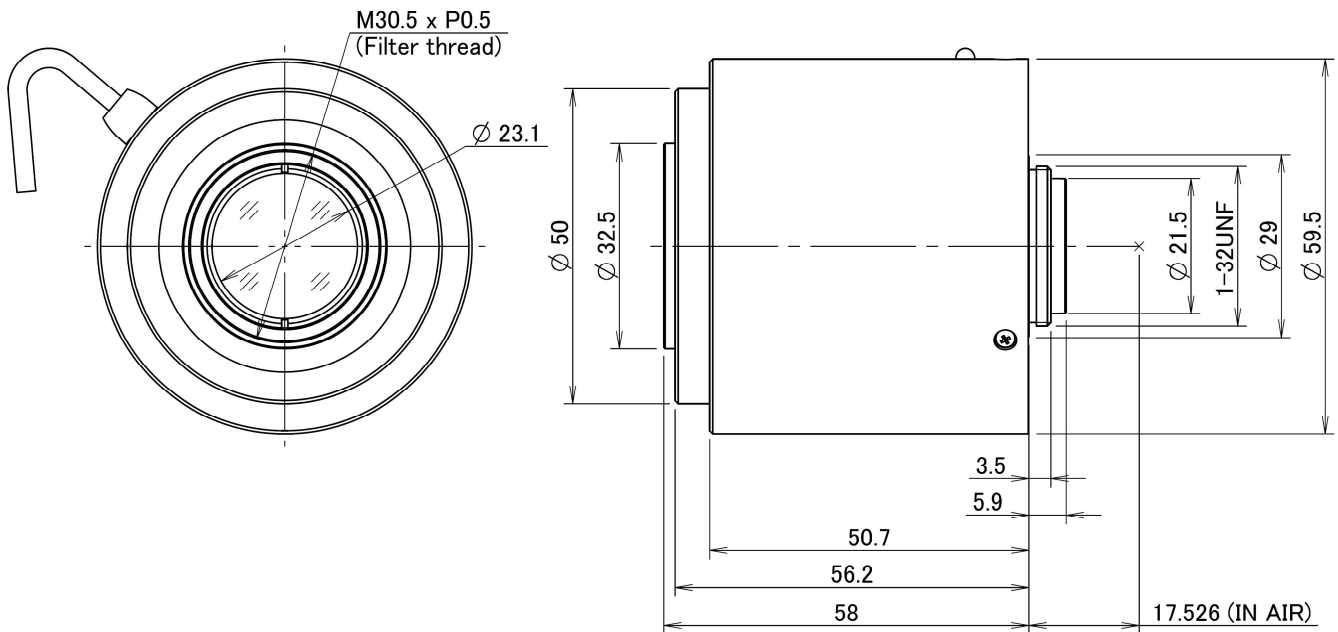

Length of Wire

300±20 (mm)

This specification is subject to change without any notice.